

Geofix 10.0



8-CCD WHEEL ALIGNMENT
FOR CAR AND LIGHT TRUCK

SISTEMA DI ALLINEAMENTO
RUOTE A 8 SENSORI CCD
PER AUTOVETTURE E VEICOLI
COMMERCIALI LEGGERI

 Quick, accurate and
simple wheel alignment

 Allineamento veloce,
accurato e semplice



Geofix 10.0



- LITHIUM BATTERIES:**
 24 hours of work, 1 year guaranteed
- BATTERIE AL LITIO:**
 24 ore di lavoro, garanzia 1 anno



- Immediate connection with innovative BT² WIRELESS COMMUNICATION**
- Connessione immediata con l'innovativa COMUNICAZIONE SENZA FILI BT²**



- FEATHERWEIGHT SENSORS:**
 only 2.6 kg
- RILEVATORI PESO PIUMA:**
 solo 2.6 kg



- SILICON ACCELEROMETER:**
 shock-proof
- ACCELEROMETRO IN SILICIO:**
 insensibile agli urti



- DESIGNED TO FIT ALSO SUV TYRES:**
 no extensions required
- ADATTO ANCHE PER PNEUMATICI SUV:**
 non richiede estensioni



- Truck and bus wheel alignment AVAILABLE WITH SMALL EXTRA CHARGE**
 Over 12m wheelbase even in outdoor sun exposed environment
- Allineamento autocarro e bus POSSIBILE CON PICCOLO SOVRAPPREZZO**
 Passo oltre 12 m anche in ambienti aperti e soleggiati



- DIRECT RECHARGE OF SENSORS:**
 no need to disassemble them
- RICARICA DIRETTA DEI RILEVATORI:**
 nessuna necessità di smontarli



- Simple and user-friendly software**
- Software semplice e intuitivo**

SOFTWARE



- FAST caster swing**
- Sterzata FAST**



- Adjust two axles in one screen**
- Regolazione di entrambi gli assi in un'unica schermata**



- Direct spoiler, no extensions required**
- Funzione spoiler automatico, non richiede l'utilizzo di estensioni**



- Clear help for adjustment**
- Visualizzazione in dettaglio delle regolazioni**

GEOFIX 10.0WE

-  Ergonomic design
 Industrial computer
 No moving parts
 (no hard disc and DVD)
 Data update through USB
 DST -Direct Shut-down
 Technology

-  Design ergonomico
 Computer industriale
 Senza parti in movimento
 (no hard-disc o DVD)
 Aggiornamento dati via USB
 DST - Tecnologia Shut-down
 diretta

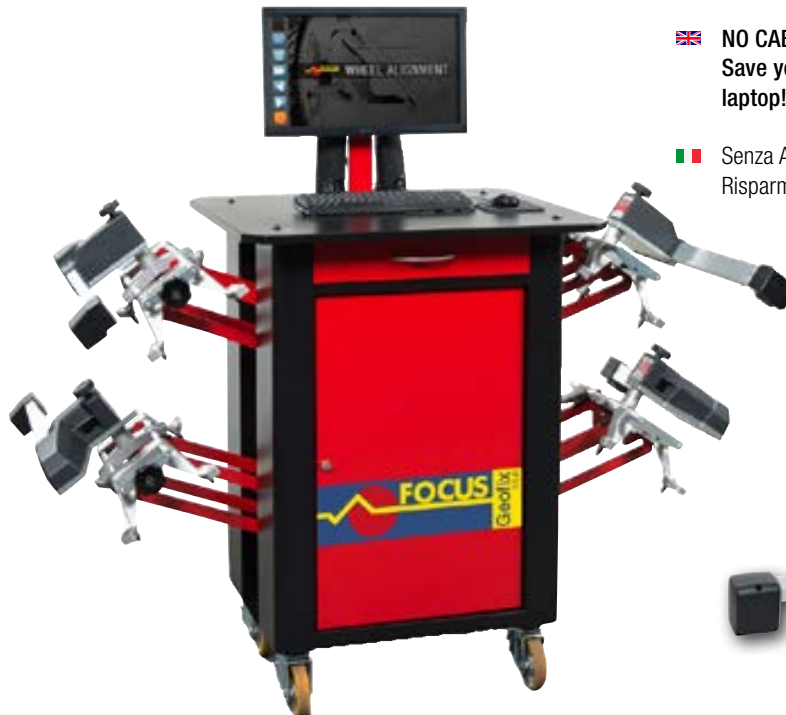

GEOFIX 10.0W Light

-  **NO CABINET!**
 Save your working space with your
 laptop!

-  Senza ARMADIO!
 Risparmi spazio di lavoro ed usi il tuo pc!



STANDARD CONFIGURATION - CONFIGURAZIONE STANDARD

OPTIONAL ACCESSORIES - ACCESSORI OPZIONALI

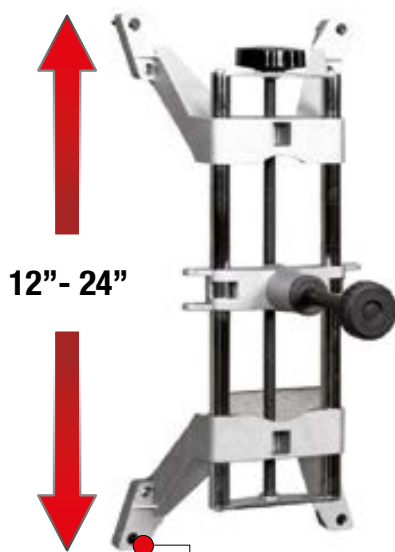

12" - 24"



-  Metal 80 mm grips
 for 4-WD, SUV, light trucks,
 and rims with hubcap
-  Unghiette metalliche 80 mm
 per 4-WD, SUV, veicoli
 commerciali leggeri e cerchi
 con coprimozzo





-  Metal 48 mm grips
 with reference surface
 to optimize runout
-  Unghiette metalliche 48 mm
 con piano di riferimento per
 l'ottimizzazione del runout



-  Optional up to 30"
-  Opzionale fino a 30"















-  Clamp supporting arms and set of tips for tyres with external
 diameter up to 31" (with optional support arms up to 40")
-  Bracci e gruppo di puntali per aggancio in appoggio a pneumatici con
 diametro esterno fino a 31" (con bracci di supporto opzionali fino a 40")

STANDARD COMPOSITION - DOTAZIONE STANDARD

GEOFIX 10.0WE

GEOFIX 10.0W Light

<ul style="list-style-type: none">  Computer - 27" monitor - printer  Computer - monitor 27" - stampante 	●	
<ul style="list-style-type: none">  Car software and database  Software e database per auto 	●	●
<ul style="list-style-type: none">  4 car sensors  4 rilevatori vettura 	●	●
<ul style="list-style-type: none">  4 clamps + safety elastic band + 2 set of grips  4 aggrappi + elastico di sicurezza + 2 set di unghiette 	●	●
<ul style="list-style-type: none">  2 car turnplates  2 piatti rotanti vettura 	●	●
<ul style="list-style-type: none">  Steering lock + Brake pedal lock  Bloccasterzo + premipedale 	●	●

TECHNICAL DATA - DATI TECNICI

OPTIONS - OPZIONI

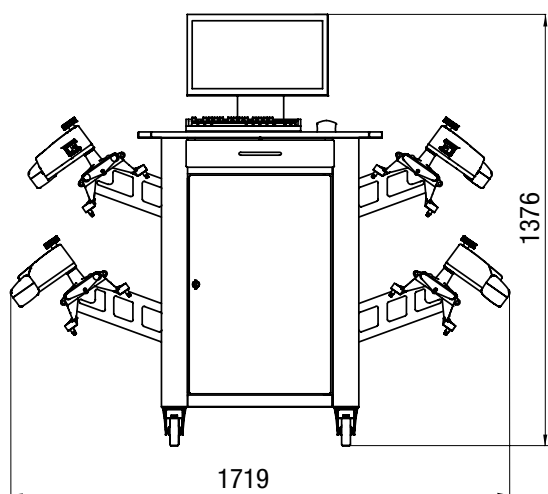

Package dimensions and gross weight:

Dimensione imballi e peso lordo:

type/tipo 1: 120x150x130h cm (47"x60"x51") 220 kg

type/tipo 2: 105x90x150h cm + 135x75x115 h cm
(41"x35"x59" + 53"x29"x45") 240 kg

Net weight / Peso netto: 155 kg

Available only in selected countries
Disponibile solo in paesi selezionati

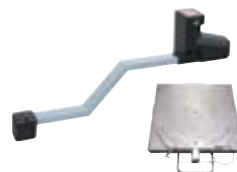

 Truck and Bus upgrade kit
 Kit di conversione auto/camion-bus





 Sensors bracket wall panel
 Pannello portarilevatori a muro



 Sensors bracket trolley
 Carrello portarilevatori a ruote



 Two Premium turntables for car
 Coppia di piatti rotanti tipo Premium



23826 Mandello del Lario (Lc) - Italy
Tel. +39.0341.706111 - Fax +39.0341.700725
www.focus-1.it

All the data and features mentioned in this catalogue are purely for information and do not constitute any commitment on the part of our company, which reserves the right to make any and all alterations it may consider suitable without notice.